

All printed copies are uncontrolled. (C) Copyright Bitec 2017

Title		FMC HDMI 2.0 DAUGHTER CARD	Bitec
Size	Document Number	TMDS RX	
B			Rev 8
Date:	Monday, April 24, 2017	Sheet	1 of 3

All printed copies are uncontrolled.

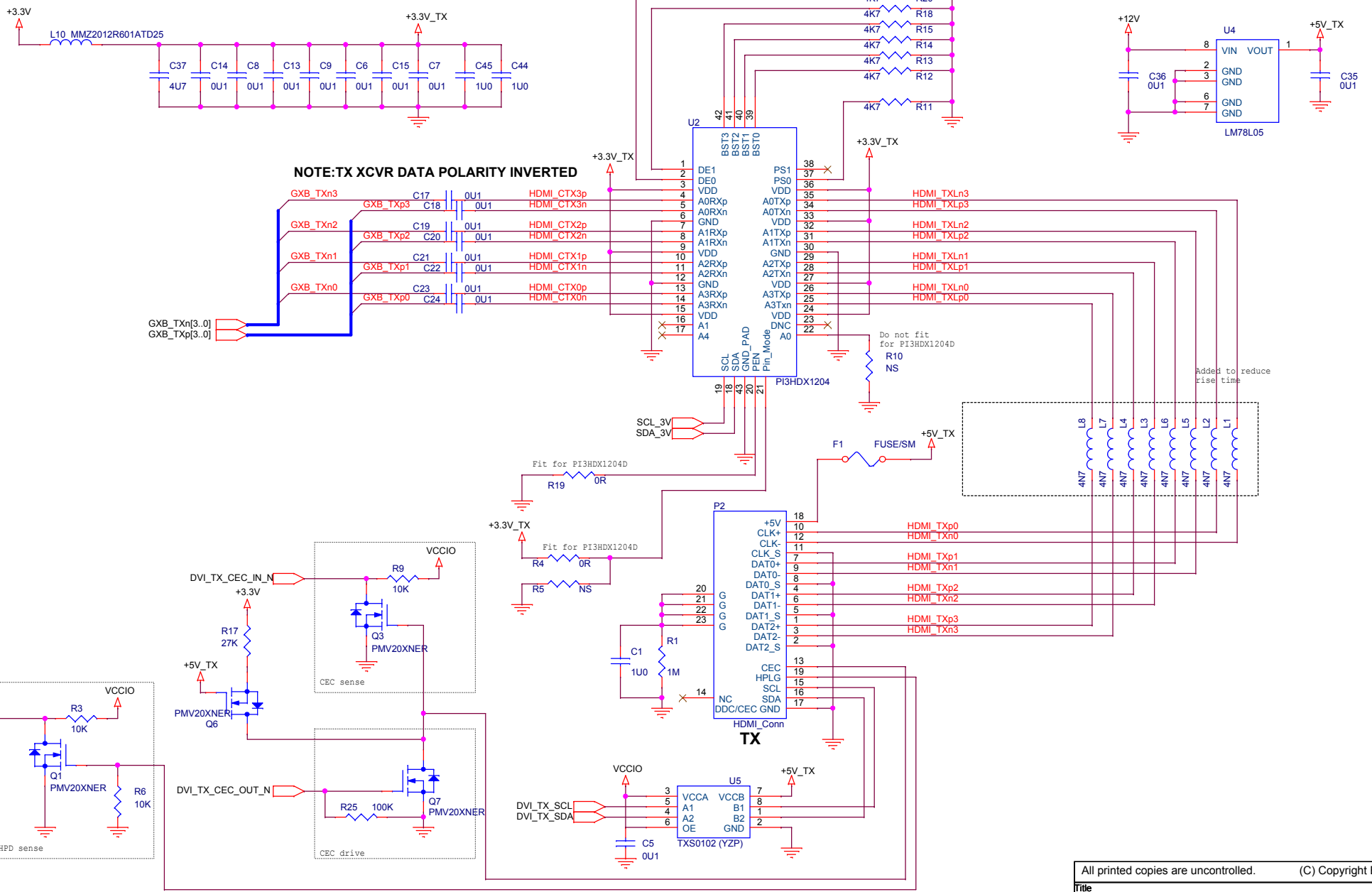

**NOTE:TX XCVR DATA POLARITY INVERTED**

Do not fit for PI3HDX1204D

Added to reduce rise time

All printed copies are uncontrolled.		(C) Copyright Bitec 2017	
Title		FMC HDMI 2.0 DAUGHTER CARD	
Size		Document Number	
B	TMDS TX	Rev 8	
Date:	Monday, April 24, 2017	Sheet	2 of 3

All printed copies are uncontrolled.

